

REQUIRED MATERIAL

1 PROFILE PLUS 4

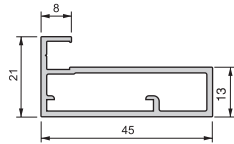

2 GLASS (Emuca does not commercialize this item)

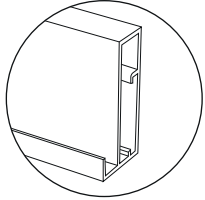
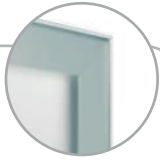
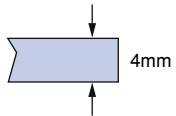

3 GASKET FOR PLUS 4 - 7

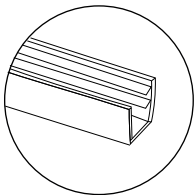

4 CORNERS FOR PLUS 4 - 11 - 14

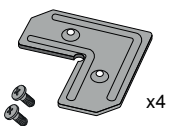

FULL OVERLAY HINGE X91 WITH SOFT CLOSE



1 PROFILE PLUS 7

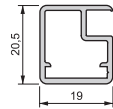
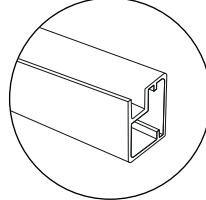

2 GLASS (Emuca does not commercialize this item)

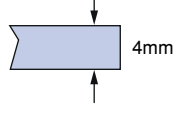

3 GASKET FOR PLUS 4 - 7

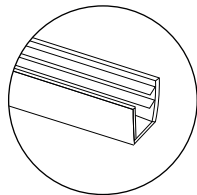

4 CORNERS FOR PLUS 7

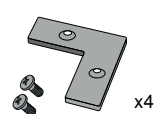

FULL OVERLAY HINGE X91N



1 PROFILE PLUS 11

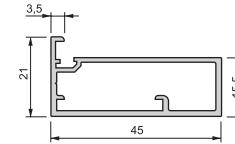
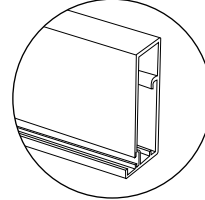
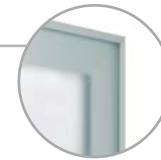

2 GLASS (Emuca does not commercialize this item)

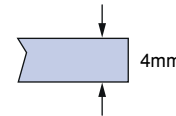

3 GASKET FOR PLUS 11

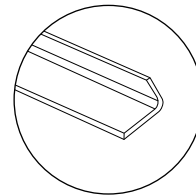

4 CORNERS FOR PLUS 4 - 11 - 14

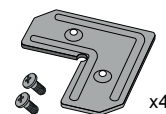

FULL OVERLAY HINGE X91 WITH SOFT CLOSE



1 PROFILE PLUS 14

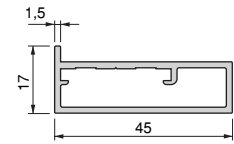
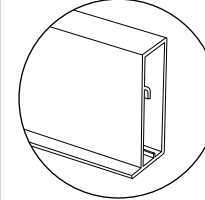

2 GLASS (Emuca does not commercialize this item)

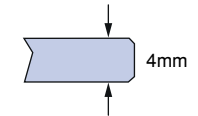

3 Double sided adhesive tape FOR PLUS 14

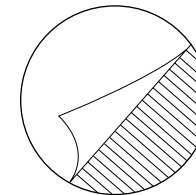

4 CORNERS FOR PLUS 4 - 11 - 14



FULL OVERLAY HINGE X91 WITH SOFT CLOSE



MATERIAL PREPARATION

1 CUTTING OF ALUMINIUM PLUS PROFILES

PLUS 4

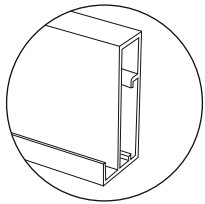

PLUS 11

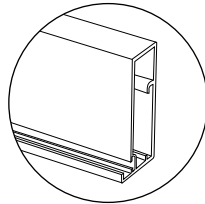

PLUS 14

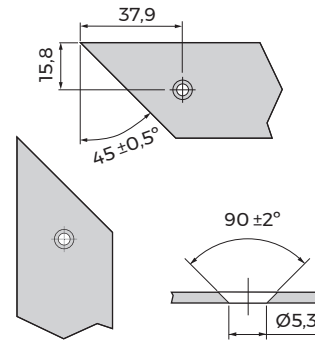
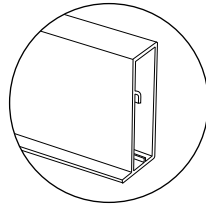

PLUS 7

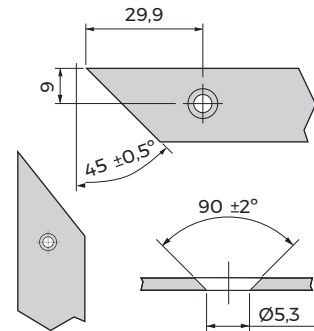
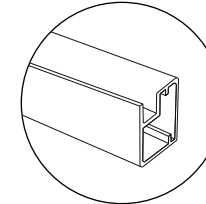

2 CUTTING GLASS

(Emuca does not commercialize this item)

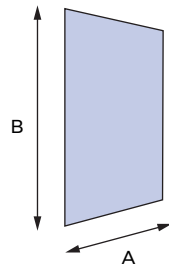
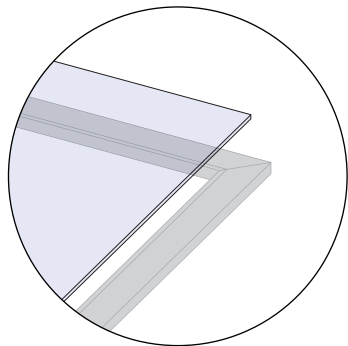

PLUS 4
A - 6mm
B - 6mm

PLUS 7
A - 27mm
B - 27mm

PLUS 11
A - 3mm
B - 3mm

PLUS 14
A - 4mm
B - 4mm

3 FITTING THE GASKET

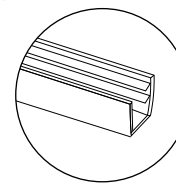

PLUS 4

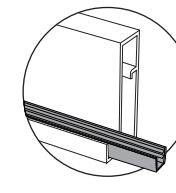

PLUS 7

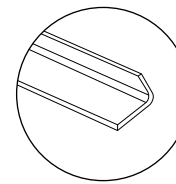
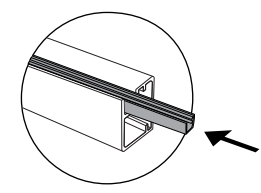

PLUS 11

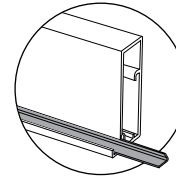

ASSEMBLY

4

PLUS 4 +
GASKET

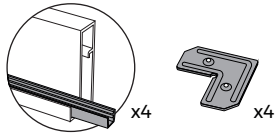

PLUS 7 +
GASKET

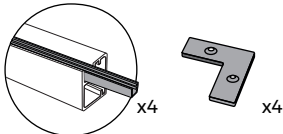

PLUS 11 +
GASKET

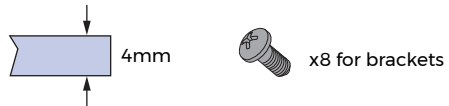
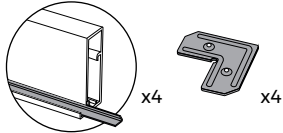

PLUS 14 +
adhesive

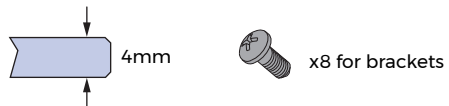
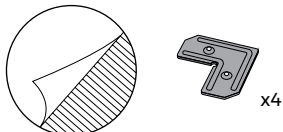

PLUS 4 - 11 - 14



x2 o x3

PLUS 7



x2 o x3

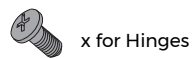

x for Hinges

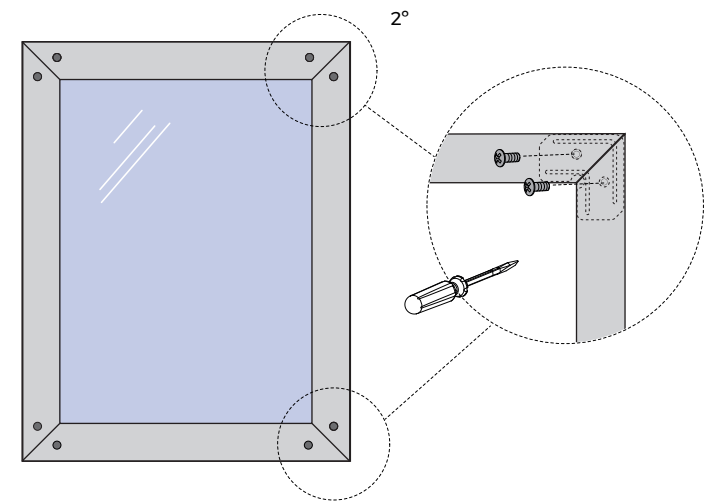
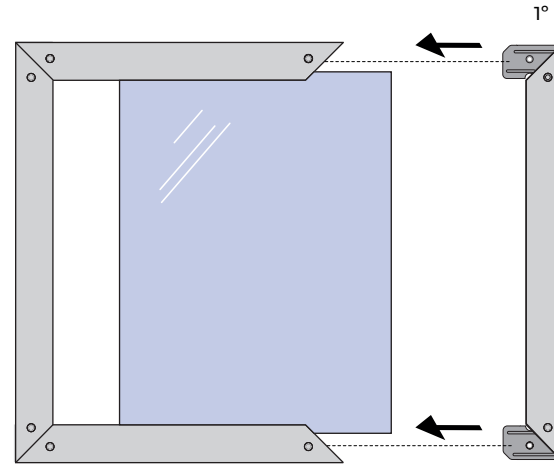

PLUS 4 - 11 - 14

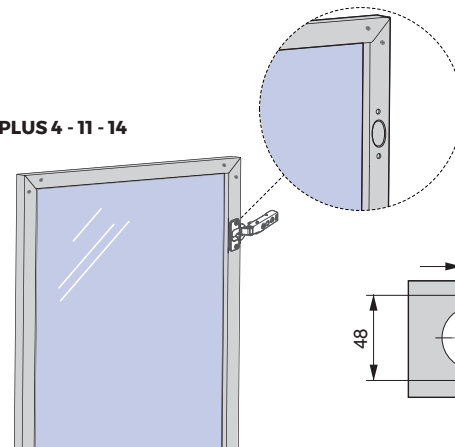

PLUS 7

