

Prof.	L	B	C
300	332	128	297
350	382	128	347
400	432	192	397
450	482	224	447
500	532	224	497

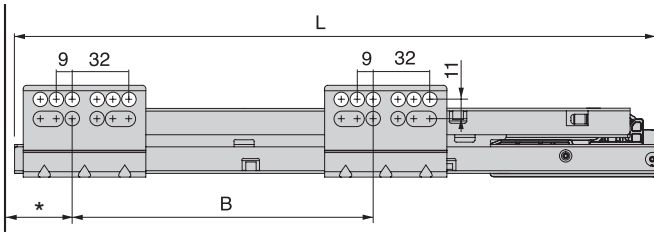

\* 37 Outer drawer / Cassetto esterno / Cajón exterior / Tiroir extérieur / Gaveta exterior  
43 Inner drawer / Cassetto interno / Cajón interior / Tiroir intérieur / Gaveta interior

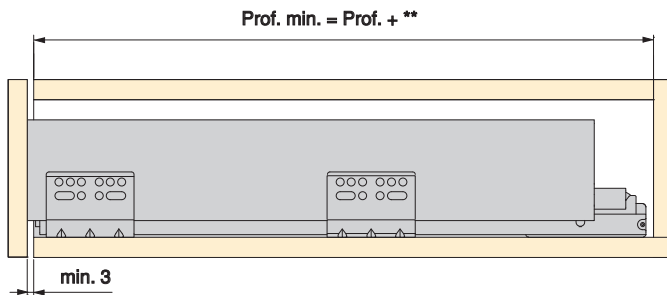
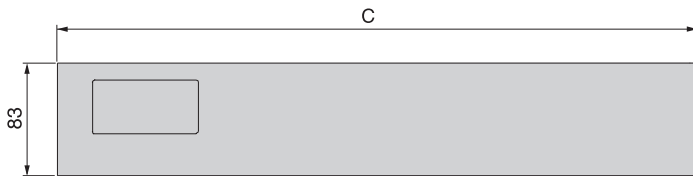

\*\* 38 Outer drawer / Cassetto esterno / Cajón exterior / Tiroir extérieur / Gaveta exterior  
44 Inner drawer / Cassetto interno / Cajón interior / Tiroir intérieur / Gaveta interior

83 mm  
Drawer  
Cassetto  
Cajón  
Tiroir  
Gaveta

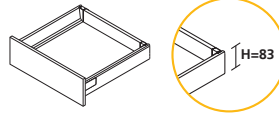

141 mm  
Drawer  
Cassetto  
Cajón  
Tiroir  
Gaveta

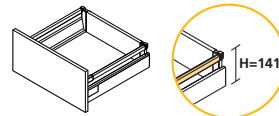

204 mm  
Drawer  
Cassetto  
Cajón  
Tiroir  
Gaveta

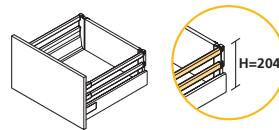

(\*)= outer drawer / cassetto esterno / cajón exterior / tiroir extérieur / gaveta exterior  
(\*\*)= inner drawer / cassetto interno / cajón interior / tiroir intérieur / gaveta interior

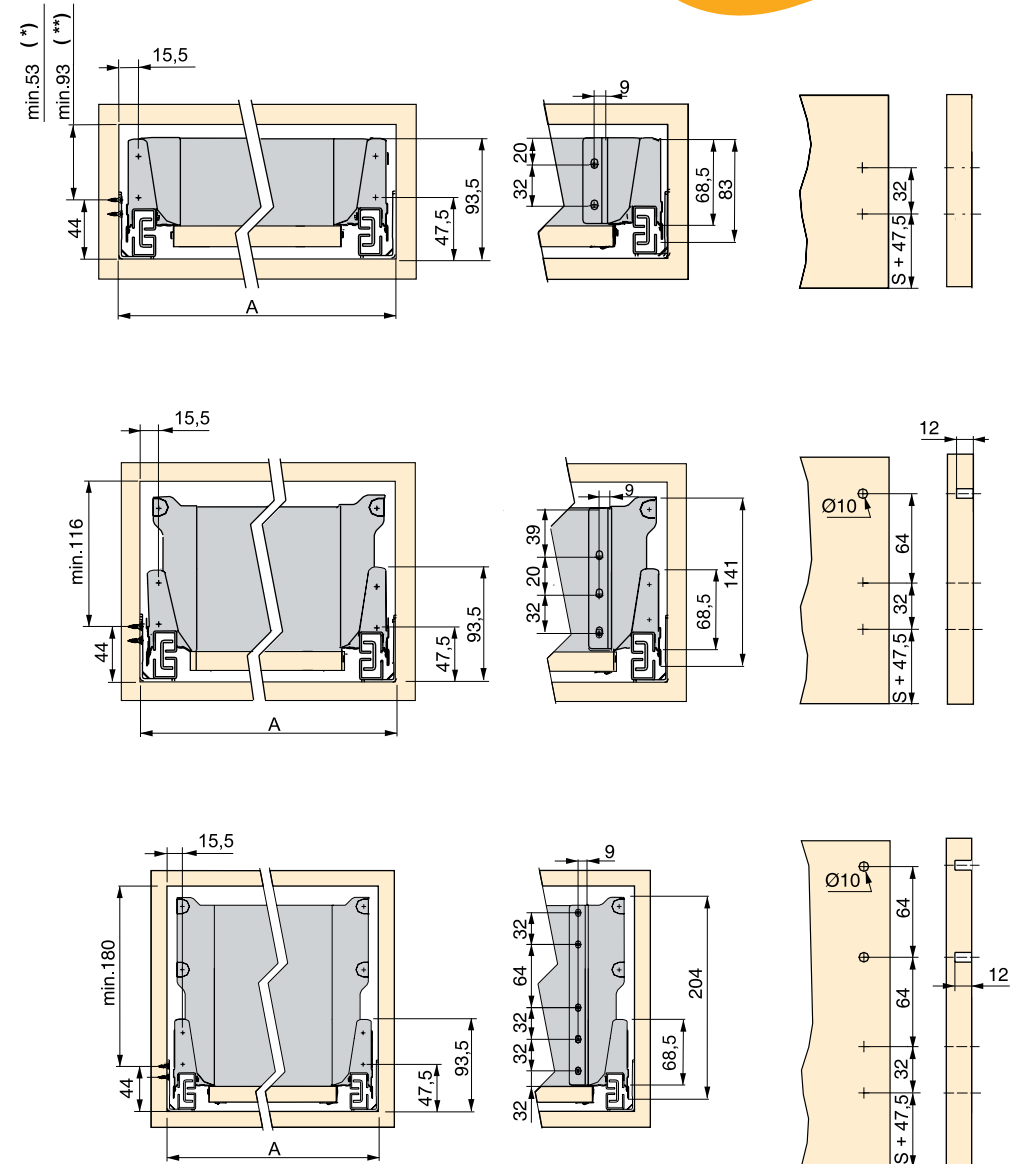

S = Overlay / Sormonto / Solape / Recouvrement / Sobreposição da ilharga

OPTION  
OPZIONE  
OPCION  
OPTION  
OPÇÃO

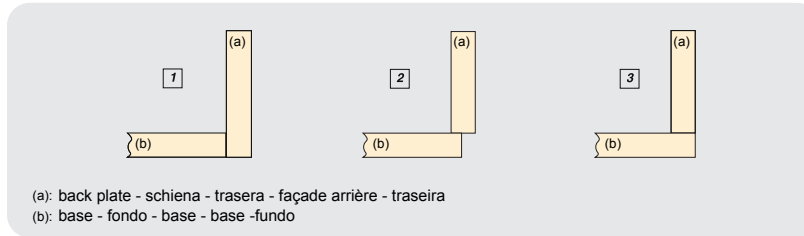

BOTTOM LENGTH - LUNGHEZZA FONDO - LONGITUD FONDO - LONGUEUR DU FOND DE TIROIR - COMPRIMENTO FUNDO

Option - Opzione - Opcion - Option - Opção		
1	2(*)	3(**)
Prof - 24	Prof - 20	Prof - 4

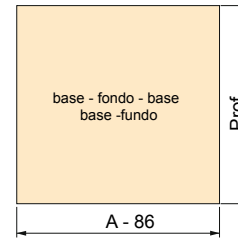

(\*) Option to assembly metal back panel.  
Opzione per montaggio de schiena metallica.  
Opción para montaje de trasera metálica.  
Option pour montage façade arrière métallique.  
Opção para montagem de traseira de metal.

(\*\*) Option 3 / Opzione 3 / Opción 3 / Option 3 / Opção 3:

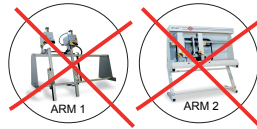

16mm = Board thickness  
Spessore pannello  
Espesor tablero  
Panneau  
Espessura do painel

DRAWER PANEL HEIGHT - ALTEZZA SCHIENA - ALTURA TRASERA - HAUTEUR FAÇADE ARRIÈRE - ALTURA TRASEIRA



		Option - Opzione - Opcion Option - Opção	
		1	2 - 3
Drawer Cassetto Cajón Tiroir Gaveta	83	84	68
	141	Ht 135	119
	204	199	183

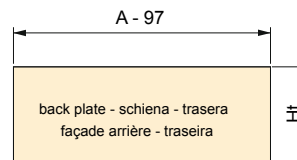

INNER DRAWER  
CASSETTO INTERNO  
CAJÓN INTERIOR  
TIROIR INTÉRIEUR  
GAVETA INTERIOR

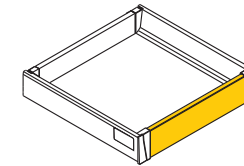

$$Ac = A - 98$$

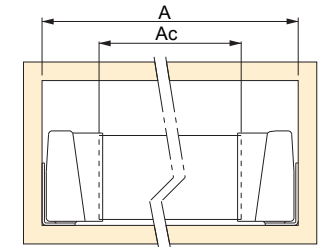

FRONTAL RAILING FOR INNER DRAWER  
ASTINA FRONTALE PER CASSETTO INTERNO  
FRONTAL RAILING FOR INNER DRAWER  
BARANDILLA FRONTAL PARA CAJÓN INTERIOR  
REHAUSSE FRONTALE POUR TIROIR INTÉRIEUR  
CERCO FRONTAL PARA GAVETA INTERIOR

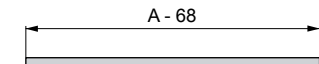
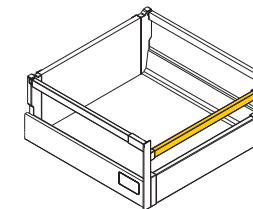

A = Inner module / Interno modulo / Interior módulo / Interieur caisson / Interior de módulo

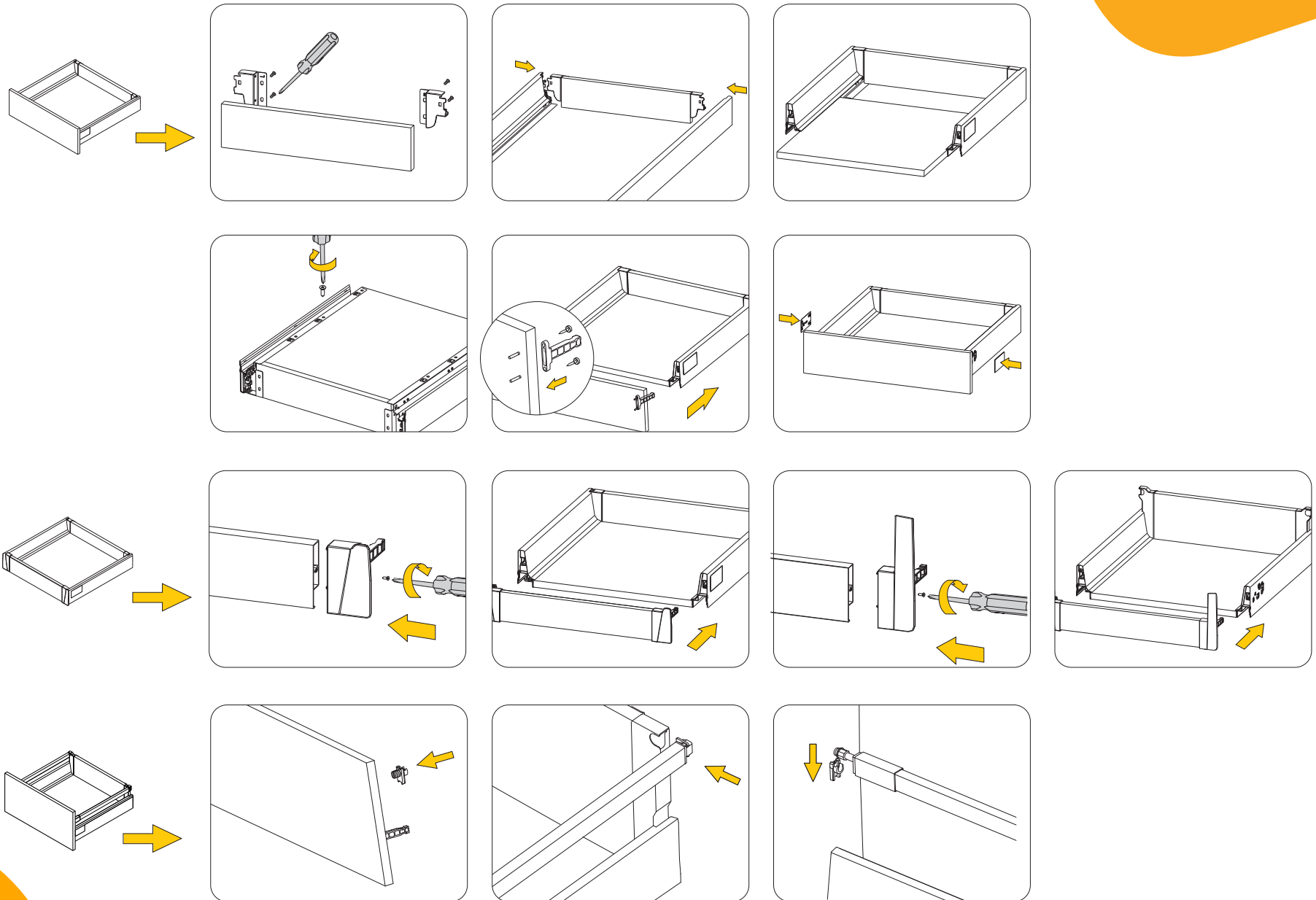
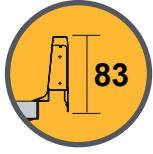

ADJUSTMENT  
REGOLAZIONE  
REGULACIÓN  
RÉGLAGE  
REGULAÇÃO

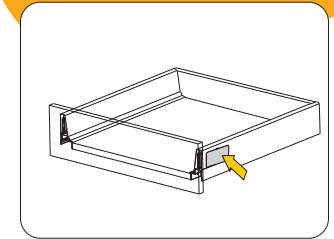
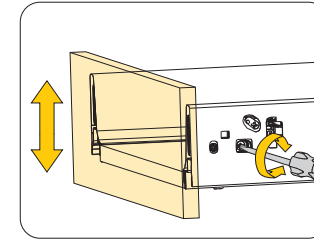
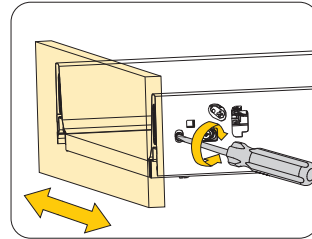
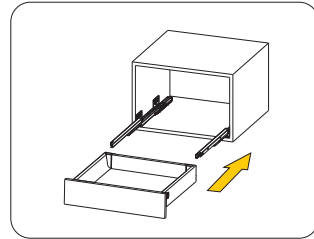

DISMOUNTING  
SMONTAGGIO  
DESMONTAJE  
DÉMONTAGE  
DESMONTAGEM

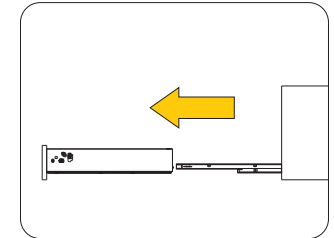
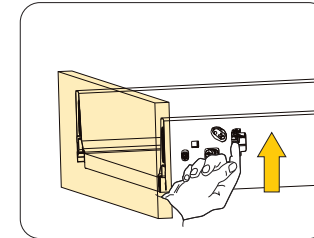
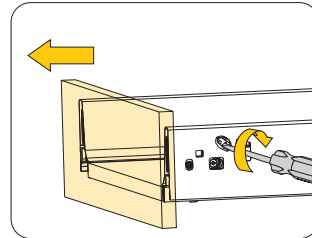
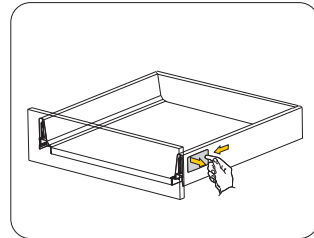

ADJUSTMENT TILT FRONT  
REGOLAZIONE DE L'INCLINAZIONE DEL FRONTALE  
AJUSTE INCLINACIÓN FRENTE  
RÉGLAGE DE LA FAÇADE  
REGULAÇÃO FRENTE

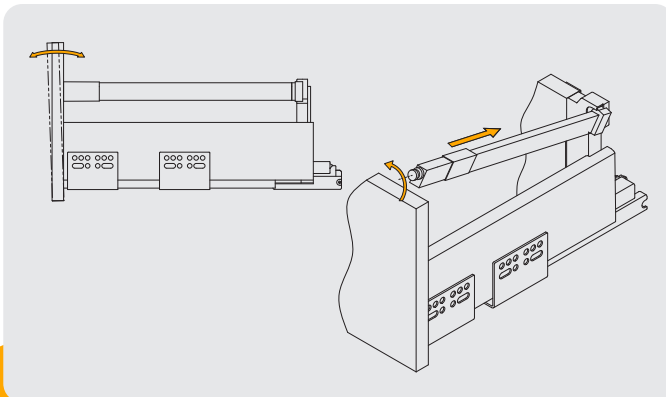

INNER DRAWER - CASSETTO INTERNO - CAJÓN INTERIOR - TIROIR INTÉRIEUR - GAVETA INTERIOR

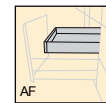

Aluminium front  
Frontalini in alluminio  
Frente de aluminio  
Façade en aluminium  
Frente de alumínio

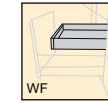

Wood front  
Frontalini in legno  
Frente de madeira  
Façade en bois  
Frente de madeira

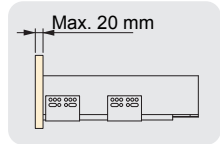
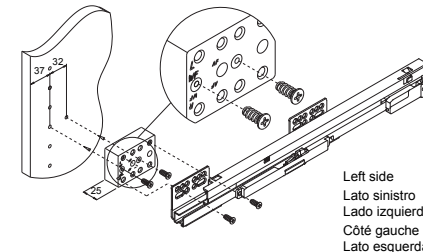
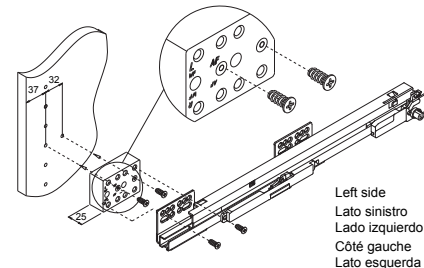
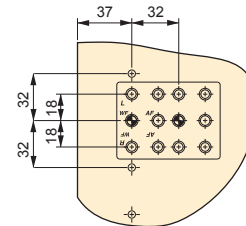
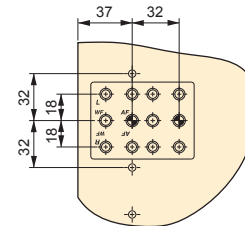

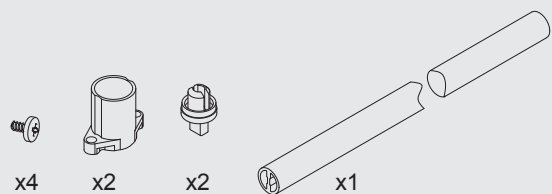

- Recomendado para módulos de anchura superior mayor de 600 mm
- Recommended for modules width upper than 600mm
- Consigliato per moduli con una larghezza superiore a 600 mm
- Recommandé pour les modules d'une largeur supérieure à 600 mm
- Recomendado para módulos com largura superior a 600 mm

